

Article number: 03489016
 Description: Fluro Rod end EAL 16D-NIRO
 Note: 16

Measures

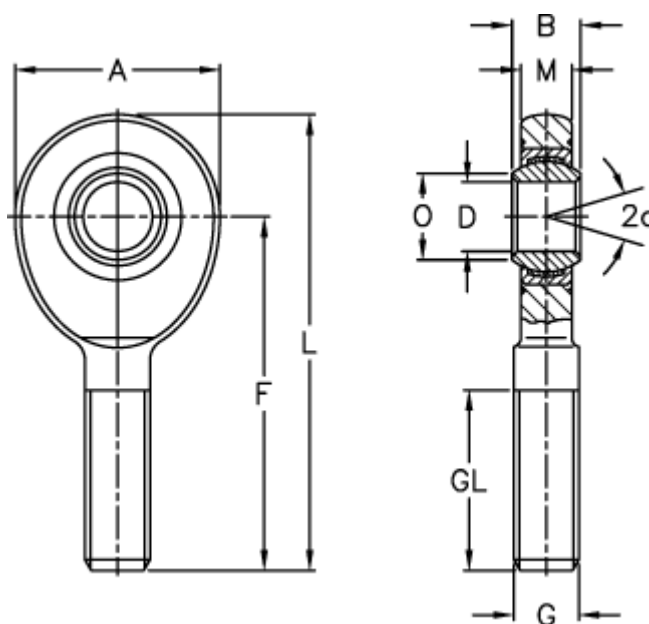

A	= 46	L	= 92
a (degrees)	= 10	M	= 11
B	= 14	O	= 20.7
D	= 16	Static drive kN	= 31.5
Dynamic drive (kN)	= 39	Weight	= 190
F	= 69		
g	= M16		
GL	= 36		